

INSTALLATION GUIDE

STANDARD PARTITION

2013 - 2019

FORD POLICE

UTILITY INTERCEPTOR

Pro-gard[™]
PRODUCTS LLC.

STRONG | RELIABLE | SECURE

pro-gard.com
800.480.6680

THESE COMPONENTS ARE REQUIRED
TO INSTALL THE PRO-GARD PARTITION SYSTEM

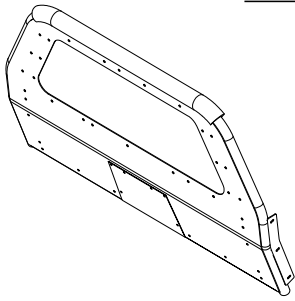

STANDARD PARTITION

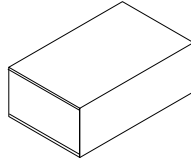

HARDWARE KIT

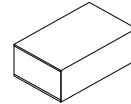

WING KIT

I. Refer to the diagram on the last page of these instructions to verify all parts were received.

II. The following tools will be required to complete the installation.

- A. 1/4" drive ratchet with 7/16" socket
- B. 3/16" Allen key
- C. 1" Hole saw
- D. Drill with 3/8" Socket

III. Read all instructions carefully before starting the assembly process.

NOTE: Locate all Wiring, Fuel Lines, Brake Lines, and/or Cooling Lines before drilling holes or installing Fasteners.

IV. B-Pillar Bracket Installation

- A. Remove Lower B-Pillar trim on the Passenger-side.
This will be reinstalled after bracket installation. (See Fig. 1)
- B. Place the Passenger B-Pillar bracket (3K4710P) against the B-Pillar face.
- C. Orientate the B-Pillar bracket so the locating tab fits into the Oval Pocket on the vehicle B-Pillar and the formed locating flanges wrap around the vehicle B-Pillar. Push over and up on the Bracket until the locating tab is at the top of the pocket and the flanges are tight against the vehicle B-Pillar edge. Insuring that the bracket is located correctly, using the supplied Self-Drilling screws (3X162) secure the B-Pillar bracket to the vehicle B-Pillar. (See Fig. 2A & 2B)

NOTE: It is critical that the seat belt strap be on the "outside" of the B-Pillar bracket. Test the seat belt to confirm that there is no interference and that it functions properly.

FIG. 1
PASSENGER SIDE SHOWN

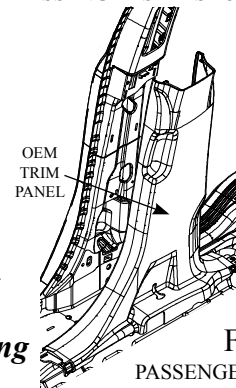

FIG. 2A
PASSENGER SIDE SHOWN

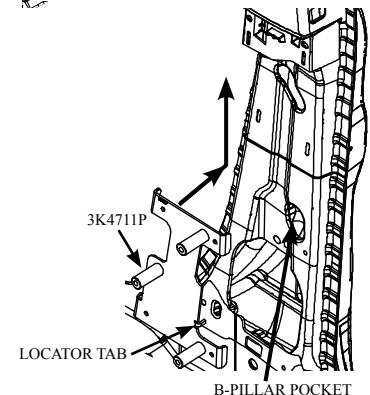
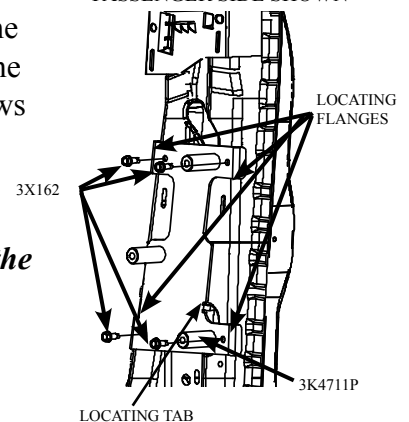
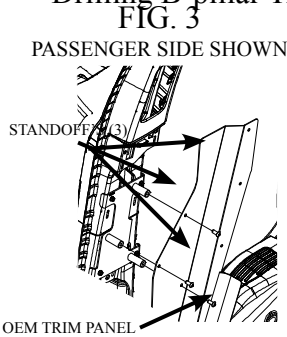

FIG. 2B
PASSENGER SIDE SHOWN



D. Using the Driver B-pillar bracket (3K4710D) repeat process on Driver-side of the vehicle.

V. Drilling B-pillar Trim Panels



A. Carefully align the template per their included instructions on to the Driver-side trim panel. Using a 1" Hole Saw drill the clearance holes as marked on the template.

B. Replace the trim panel, insuring that the standoff's protrude through the panel. (See Fig. 3)

C. Repeat process on the Passenger-side trim panel.

VI. Installing Partition Mounting Plates

A. Attach the Passenger-side Mounting Plate (3K4711P) using the supplied 5/16-18 x 3/4" Button head screws (3X149) to the Standoff's protruding through the B-pillar trim. Hand tighten fasteners only. (See Fig. 4)

B. Repeat process on the Driver-side

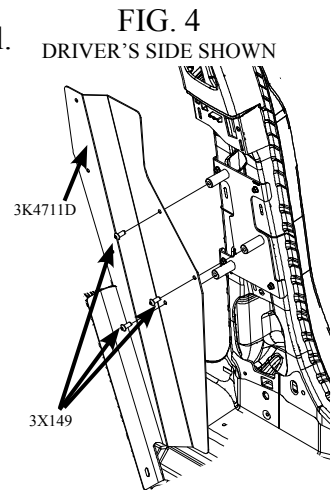

VI. Partition Installation

A. Due to the weight and size of the partition, assistance from another party is highly recommended. Insert the partition into the vehicle, lift and position the partition so that it aligns with the Partition Mounting Plates, using the supplied 1/4-20 x 5/8" Carriage Bolts (3X36) and 1/4-20 Whiz nuts (3X16Z) secure the Partition to the Mounting Plates. Hand tighten fasteners only. (See Fig. 5)

B. Audit the overall installation for fit and function of all componets, insure all fasteners are tight.

VII. Filler Wing Installation

A. The Filler Wings and their mounting hardware are packed in separate box marked Wing Kit. Install the Filler Wings according to their included Install Instructions.

VII. Seat Protector Installation *Optional Product*

A. The Seat Protector(s) and their mounting hardware are packed in separate box. Install the Seat Protector(s) according to their included Install Instructions.

VIII. Installation is now complete.

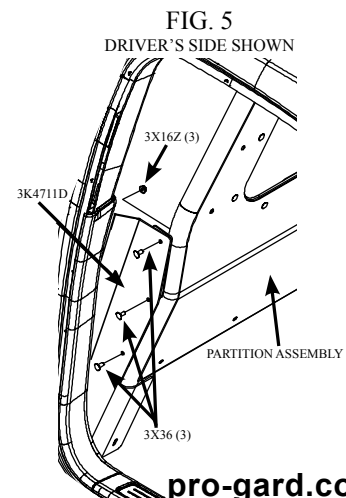

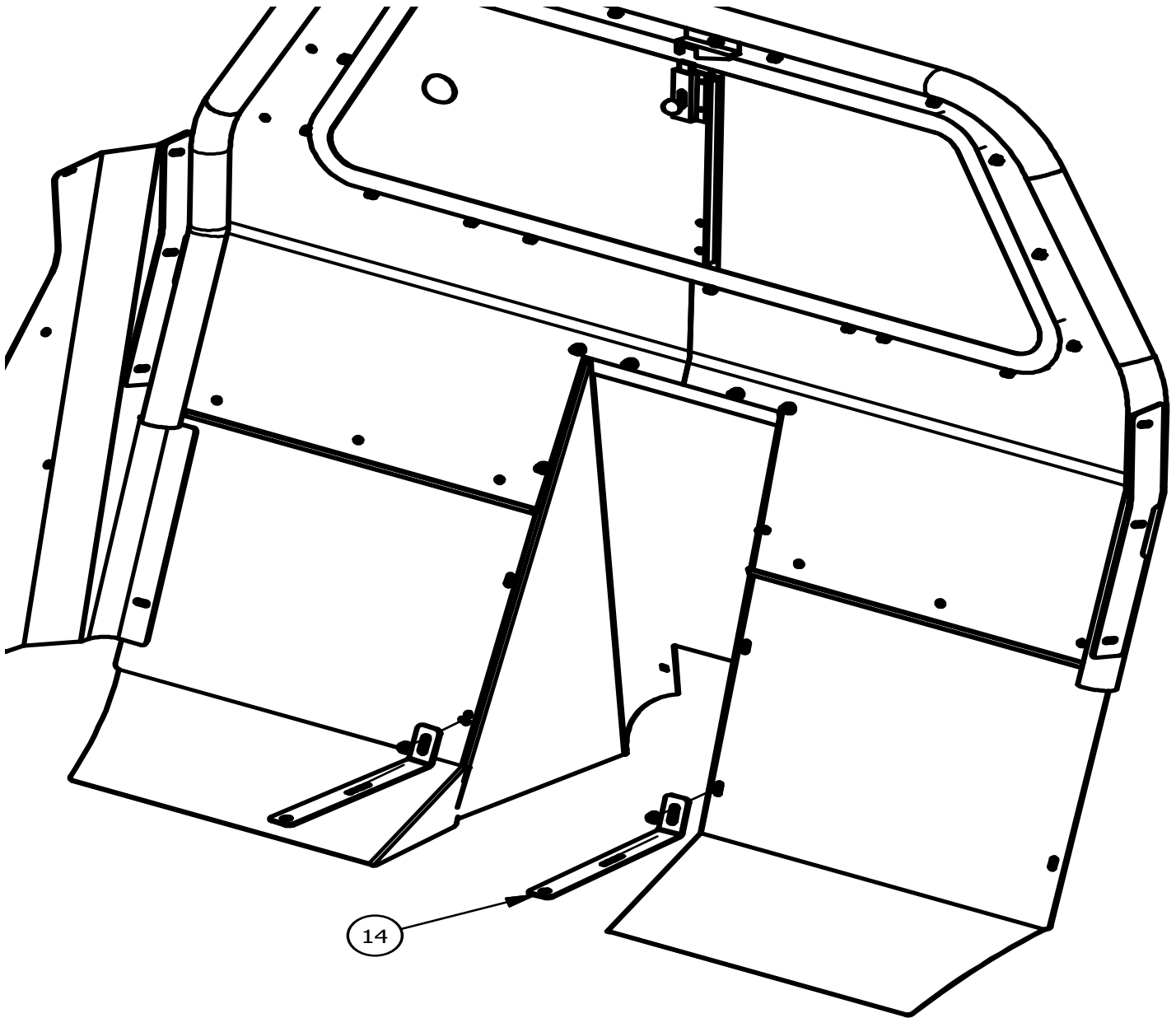

VIII. Stiffening Bracket Installation (Used Only With Item 11 & 12)

- A. The stiffening brackets utilize the inner-hole locations on the bottom of the passenger and driver-side seat protectors. (3SP4712P & D) The hardware used is the same 3X36 bolts and 3X16Z whiz nuts used to secure the panel. Remove the whiz nut, then slide the stiffening bracket over the exposed stud of the 3X36 bolt. Then, tighten the whiz nut down securely. Repeat on the other side.

IX. Installation is now complete.

PARTS LIST

ITEM	QTY	PART NUMBER	DESCRIPTION
1	1	VARIES	Partition Assembly
2	1	3K4710P	B-PILLAR BRACKET - PASSENGER
3	1	3K4710D	B-PILLAR BRACKET - DRIVER
4	1	3K4711P	MOUNTING PLATE BRACKET - PASSENGER
5	1	3K4711D	MOUNTING PLATE BRACKET - DRIVER
6	6	3X36	1/4-20 X 5/8" CARRIAGE BOLT
7	6	3X16Z	1/4-20 WHIZ NUT
8	6	3X149	5/16-18 X 3/4" BSCHS, BLK
9	8	3X162	1/4 X 3/4" SELF DRILLING SCREW
10	1	3SP4715	*OPTIONAL * LEP, FULL WIDTH
11	1	3SP4712P	*OPTIONAL * LEP, PASSENGER, SPLIT
12	1	3SP4712D	*OPTIONAL * LEP, DRIVER, SPLIT
13	1	3RP4713	*OPTIONAL * RECESSED PANEL
14	2	3K4713001	STIFFENING BRACKET

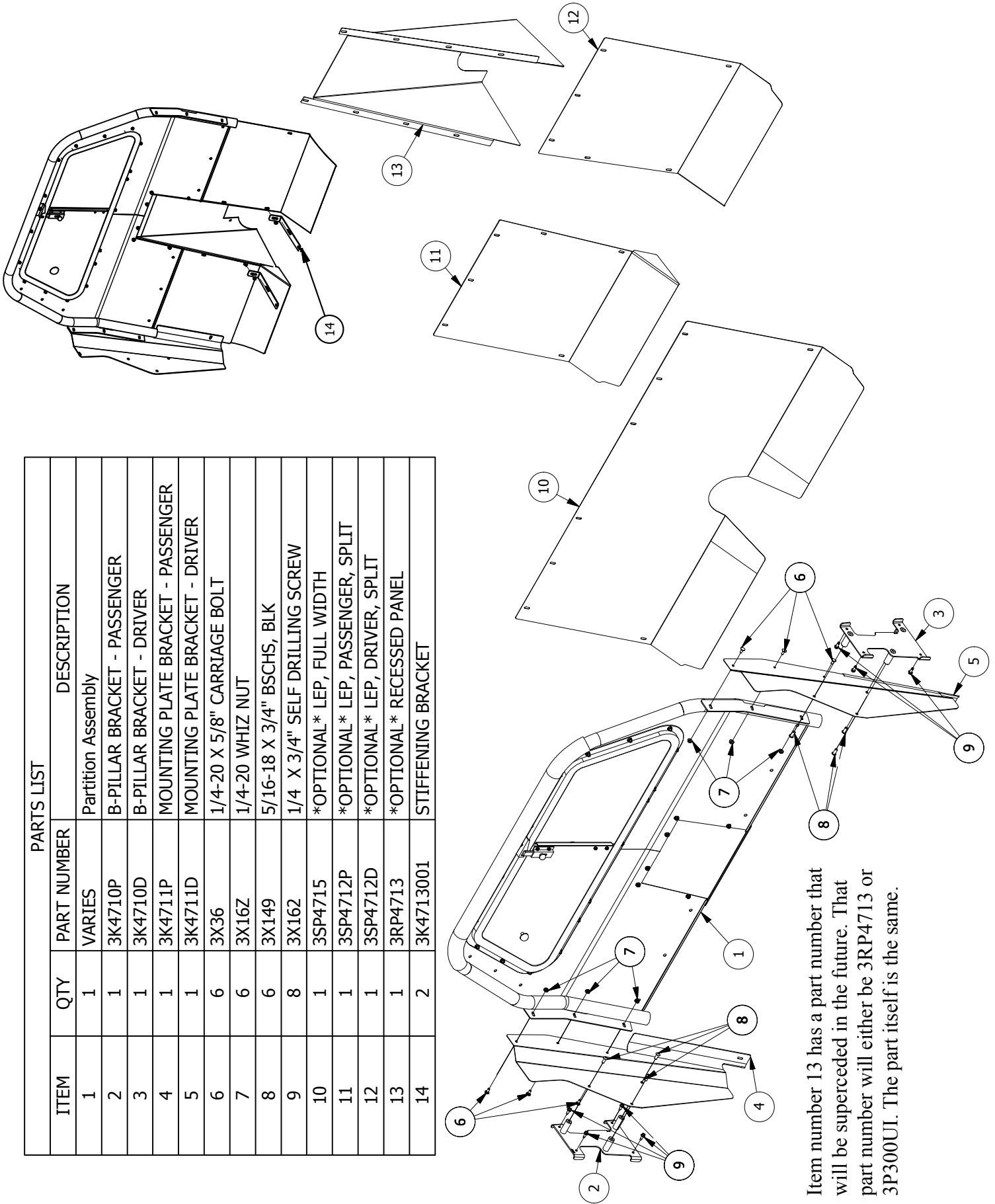

Item number 13 has a part number that will be superseded in the future. That part number will either be 3RP4713 or 3P300UI. The part itself is the same.

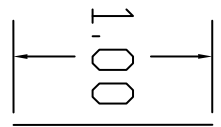

CHECK SCALE

SELECT NONE FOR PAGE SCALING WHEN PRINTING FROM .pdf FILE

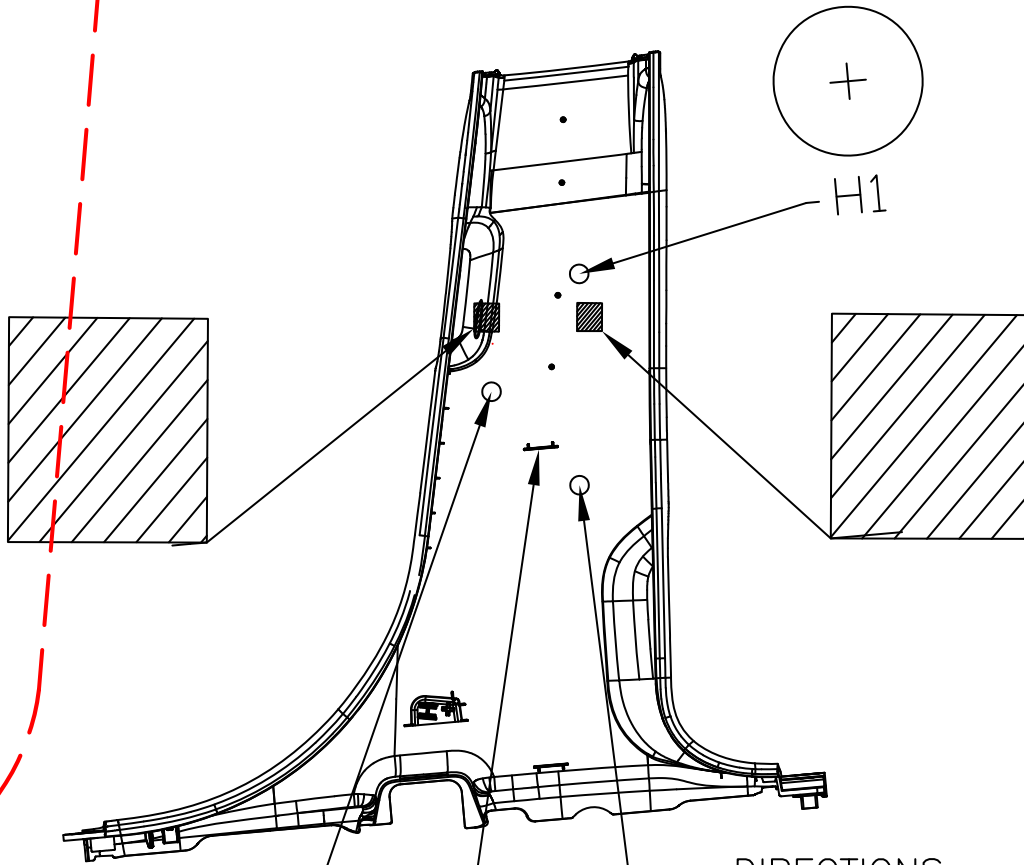

DIRECTIONS

1. CUT ALONG DASHED LINES
2. CUT OUT HATCHED AREAS
3. ALIGN CUT OUT AREAS WITH THEIR CORRESPONDING BOSS ON OEM B-PILAR TRIM PANEL
4. CENTER PUNCH 3 HOLE LOCATIONS THRU TEMPLATE & DRILL/CUT 1" DIA. HOLE
- 5 REINSTALL B=PILARR TRIM PER INSTALL INSTRUCTIONS

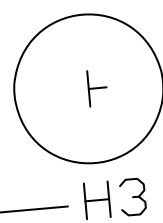
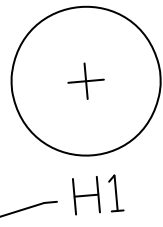
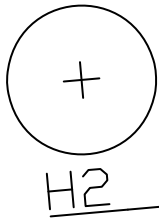

2013-CURRENT
FORD POLICE UTILITY INTERCEPTOR
B-PILLAR TRIM TEMPLATE-DRIVER

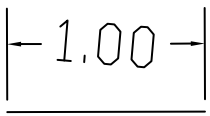

CHECK SCALE

SELECT NONE FOR PAGE SCALING WHEN PRINTING FROM .pdf FILE

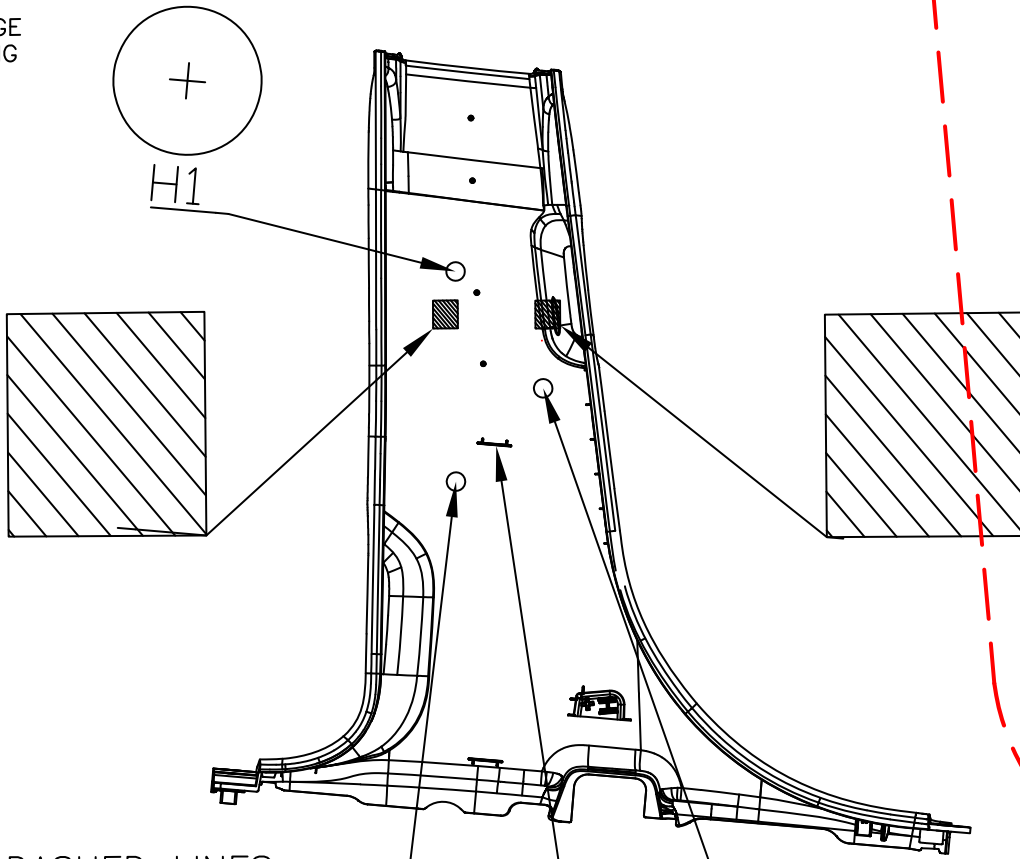

DIRECTIONS

1. CUT ALONG DASHED LINES
2. CUT OUT HATCHED AREAS
3. ALIGN CUT OUT AREAS WITH THEIR CORRESPONDING BOSS ON OEM B-PILARR TRIM PANEL
4. CENTER PUNCH 3 HOLE LOCATIONS THRU TEMPLATE & DRILL/CUT 1" DIA. HOLE
- 5 REINSTALL B=PILARR TRIM PER INSTALL INSTRUCTIONS

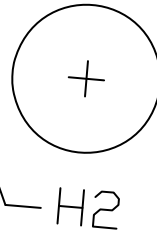
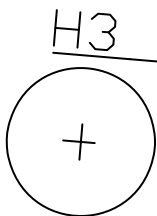

2013-CURRENT
 FORD POLICE UTILITY INTERCEPTOR
 B-PILLAR TRIM TEMPLATE-PASSENGER