

2006 IMPALA INSTALL INSTRUCTIONS FOR THE PRO-GARD

SEAT AND FLOOR PAN MODEL S52I06/FP52I06

I. Check to insure the following parts are included in your package.



SEAT
3S52I06
(1) EACH



FLOOR PAN
3F52I06
(1) EACH

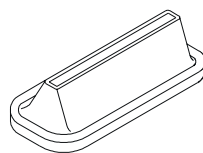

GROMMET
3S5001
(2) EACH



DRAIN PLUG
3S601
(2) EACH



#8 5/8" PHILLIPS HEAD
TRUSS HD
3X72
(8) EACH

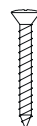

#10 1 1/2" OVAL, PHILLIPS HEAD
SELF TAPPING SCREW
3X77
(8) EACH

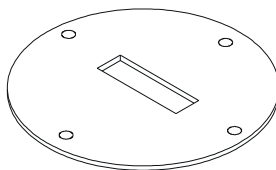

COVER PLATE ("PUCK")
4S6000C
(2) EACH



#10 FINISH WASHER
3X78
(8) EACH

II. You'll need the following tools:

- A. Drill
- B. 3/16" Drill Bit
- C. Phillips Head Screwdriver
- D. Socket Wrench
- E. 10, 13, 15 and 18mm Sockets
- F. 10" extension

FIGURE A

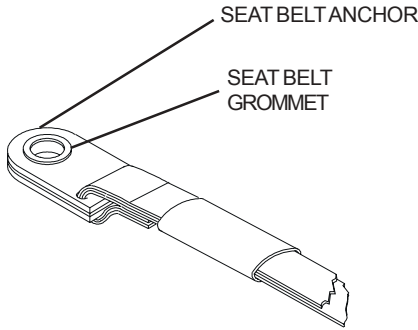

NOTE: For reassembly, the Seat Belt Grommet and Sheath must be removed. This will allow the Seat Belts to be threaded through the Seat Grommets. See Figure B

IV. Remove the center rear Seat Belt assemblies. You can now reinstall the nuts retaining the shoulder harnesses that were removed to extract the seat back. Torque to manufactures specs.

V. Remove the O.E. Seat Belt assembly Grommet and Sheath from the center Seat Belt Assemblies as shown in Figure A. Install the rubber grommets in the coverplate (puck) assemblies. Thread each Seat Belt through the Seat Grommet, shown in Figure B.

FIGURE C



III. Remove the manufactures installed rear seat bottom and backrest assembly, you must remove the two outer 18mm nuts. The two outer nuts can be reinstalled once the backrest is removed. Properly store the rear seat in an appropriate location. Retain the remaining two 18mm nuts for later installation of the center seat belts, if you have removed the center seat belts at this point.

FIGURE B

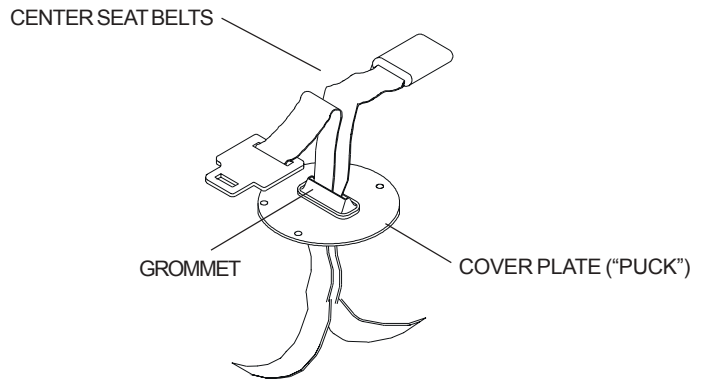

NOTE: To thread the seat belt straps through the grommet you must:

1. Install the grommet into the slot of the cover plate, as shown in Figure B.
2. Place the cover plate in a vice if available.
3. Thread and pull the straps through.

VI. Place the Seat into the rear of the car. *Tip the back edge in at an angle 10" to 12" below package shelf and then slide back and then upward.* Be careful not to trap the outside seat belts or shoulder straps under the seat. Seat must go under seat belt retaining clip that is attached to "C" Pillar. Reinstall the Seat Belts to the Seat Belt Anchors using the seat access holes. Place belt over each respective Anchor Stud. Replace the Anchor Nut and Tighten to manufactures specs.

VII. It is recommended that a small bead of clear silicone be used in the mounting area before the "puck" is screwed in place for a complete seal. Attach the

FIGURE D

ANCHOR NUT

ANCHOR STUD

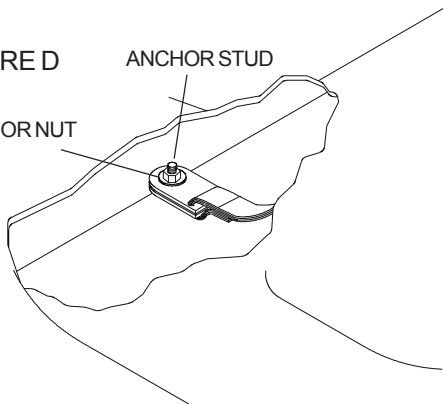

cover plate to the seat with the four self tapping screws (3X72). Take care not to strip the threads by over tightening. *Note: Coverplate will form to the contour of seat.*

VIII. Adjust Seat for correct placement. Insure that each anchor point (shown in Figure F) has metal support behind it. Drill Pilot holes in the seat only, not the metal support behind, drill each Pilot Hole with a 3/16" diameter drill bit. Insert a Self Tapping 1 1/2" Screw through a Finish Washer and place the Screw through each pilot hole and tighten as necessary to secure the Seat into

place.

FIGURE E

PLACEMENT OF ATTACHING SCREWS AND FINISH WASHERS



FLOOR PAN INSTALLATION

FIGURE F

DRAIN PLUG
3S601
(2) EACH



IX. Install the floor pan (PF52I06) before installing the Pro-gard seat.

A. Remove the O.E.M seat as stated previously.

B. Place the FP52I06 Floor Pan in the floor of the car. Using the existing holes in the pan as a template, drill the two drain plug holes through the floor and insert the drain plugs. This is necessary when cleaning.

C. Finish installation per parts II, VIII and IX.

P1000I06
INSTALLATION INSTRUCTIONS
2006 CHEVY IMPALA
PRO-CELL PARTITION INSTALL



- **BE SURE TO CAREFULLY REVIEW ALL INSTRUCTIONS BEFORE INSTALLATION.**
- **BEFORE DRILLING HOLES INTO THE VEHICLE, BE SURE TO LOCATE ANY BRAKE LINES, FUEL LINES, OR ANY OBJECT THAT MAY BE IN THE WAY**
- **NOT COMPATIBLE WITH SIDE CURTAIN AIRBAGS**
- **PARTITION IS DESIGNED TO BE USED IN '06 CHEVY POLICE IMPALA ONLY**

NOTE: Carefully review the parts list below. If there are any missing parts, please call (317)-579-6680 and ask for "Customer Service" or circle the missing part on this sheet and fax to (317) 579-6681. Be sure to locate important vehicle components: wires, fuel lines, brake lines, etc., before drilling holes

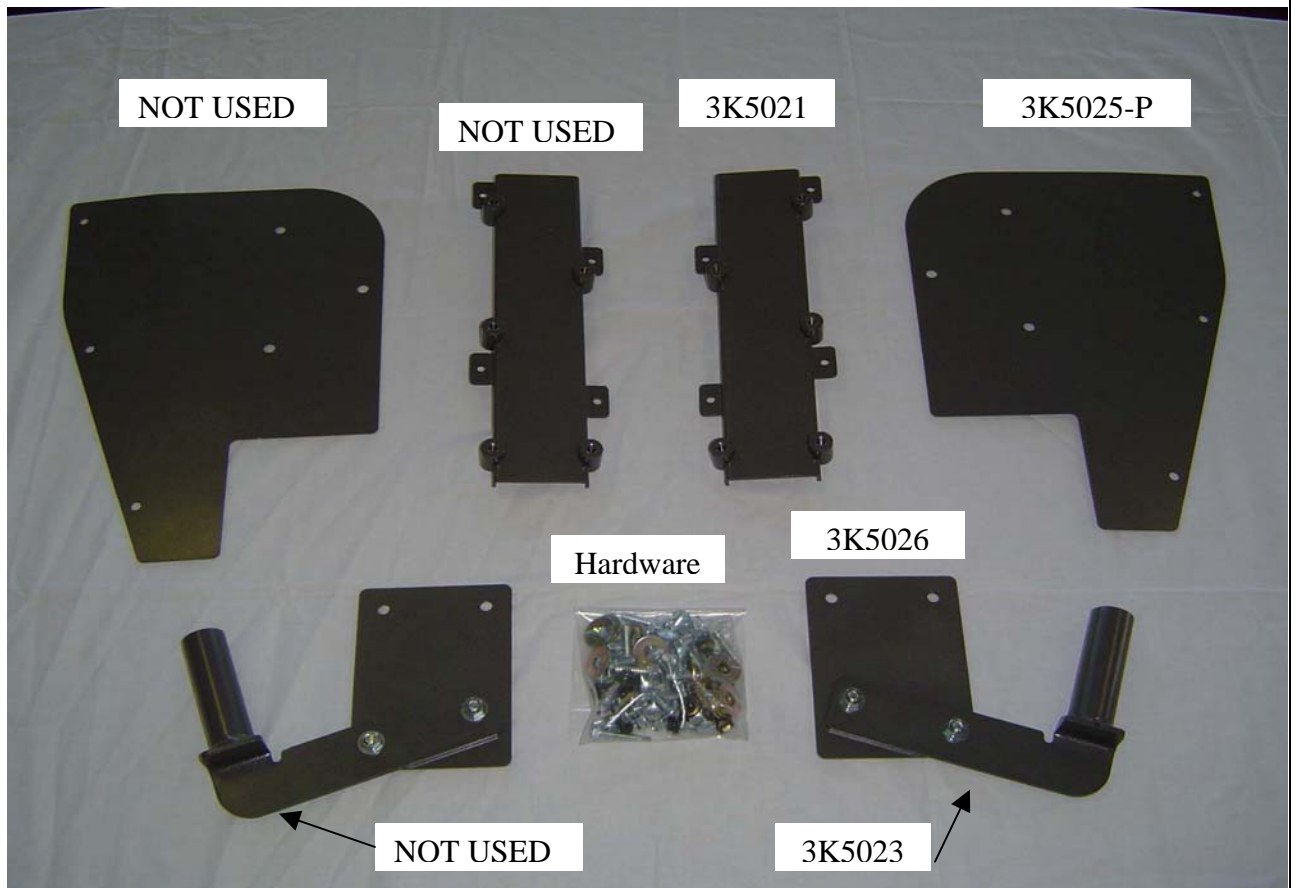

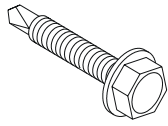

3X110
1/4-14 X 1 SLF DRL,
WASHER HD. ZN
(4)



3X16
1/4-20 WHIZ
WASHER HEX
NUT
(3)

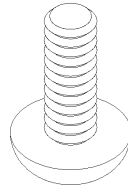

3X149
5/16-18 X 3/4" BUTTON
SOCKET HEAD SCREW
(5)

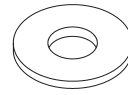

3X12
1/4-20 BLACK FLAT
WASHER
(5)

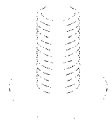

3X61
1/4-20 X 3/4 CARRIAGE
BOLT
(6)



3X16Z
1/4-20 WHIZ WASHE
HEX NUT
(3)

Note: Read all instructions carefully before installing the partition.

I. B-Pillar Bracket Installation

- A. Begin by removing the middle B-pillar section. (**Fig. 1**) This will be reinstalled after drilling holes into the cover. Use the template provided as a guide for drilling 1" holes. Remove the four material tabs that are located near the top and the bottom of the cover (**fig. 2**). This will allow the paper template to lie flat on the inside surface (**fig. 3**). Notice that there are two smaller holes at the top of the template. These holes will align with the two existing material bosses at the top of the cover. See the following



Fig. 1

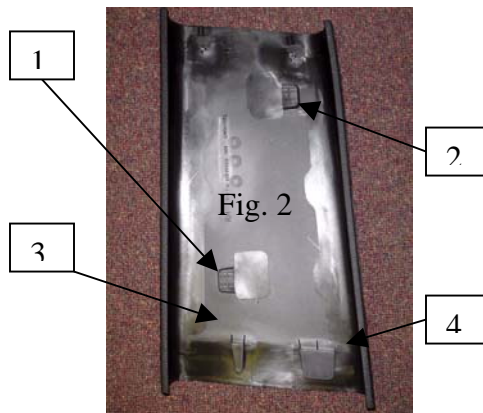

Fig. 2



Fig. 3



Fig. 4

OEM
Vertical
Slots



Fig. 5

- B. Install the B-pillar bracket (3K0521 passenger). Using the bracket side hooks as guides, insert the bracket into the OEM vertical slots in the b-pillar frame (**fig. 4**). Once you have inserted the bracket into position, locate the four tabs and secure it with four of the 3X110 self-drilling screws (**fig. 5**). You can now replace the b-pillar cover. (See **fig. 6**)



Fig. 6



Fig. 7

II. Partition Installation

- A. Using the assembled brackets (3K5023 and 3K5026), mount them to the lower studs protruding through the b-pillar cover (**fig.6**). **Mount the bolt to the rear of the vehicle first (fig. 7).** Make sure that the brackets are mounted in the same manner on both sides.

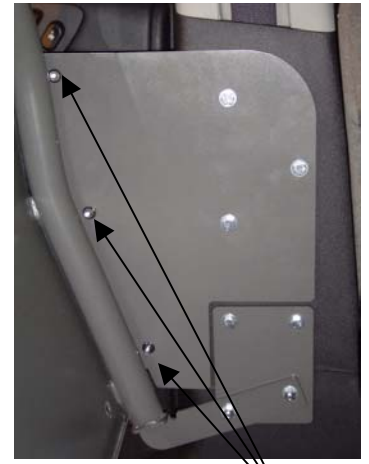

Fig. 8

- B. You will now insert the partition into the vehicle. Due to the weight and size of the partition, assistance from another party is highly recommended. Insert the partition tubes onto the tubes of the brackets you just installed. Now, you can easily lift and position the partition so that the other bolt can be inserted into the stud toward the front of the vehicle. Once the partition is set into position, install the mounting plate: 3K5025 passenger, using the 3X149 button head bolts and 3X12 flat washers. To mount the partition to the rear of the plate, use the 3X61 carriage bolts and the 3X16 black whiz nuts (**fig. 8**).
- C. To secure the partition, mount the other end using the 3X82 carriage bolts and the 3X16Z whiz nuts.
- D. Mount the 5206-center divider on the inside of the partition-mounting bracket. This can be best accomplished by inserting the divider through the passenger side (**fig. 9**).

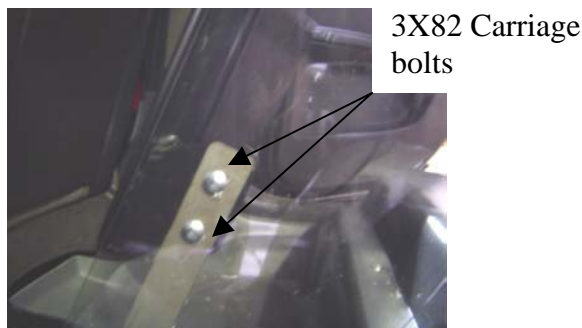

Fig.9

II. Wing Installation

- A. You are now ready to install the side panel wing. Using the existing 3 holes provided in the top corners of the partition, mount the wings (4W52P passenger) using the 3X61 carriage bolts and the 3X16Z whiz nuts (**fig.10**).



Fig.10

Extra Component

Component available for the '06 Impala partition:

SP52BS06 Bucket Seat Protector

IF YOU HAVE ANY QUESTIONS OR CONCERNS PLEASE CONTACT

**PRO-GARD PRODUCTS, LLC
PHONE: 317-579-6680**

PRO-GARD PRODUCTS, LLC
2006 CHEVY IMPALA
DOOR PANEL AND WINDOW BAR
INSTALLATION INSTRUCTIONS



NOTE: Carefully review the parts contents list below and familiarize yourself with these parts. If there are any missing components, call (317) 579-6680 and ask for “Customer Service”, or circle the missing part on this sheet and FAX it to:

“PRO-GARD CUSTOMER SERVICE”
@ (317) 579-6681

Read all instructions before beginning installation.

1. Remove O.E.M rear **door panel** using the correct tools.

2. Remove the “insulation shield” behind the O.E.M panel by gently peeling away the sticky foam. Secure the window switch assembly, and remove the manual door lock rod. The window switch must be secured with tie-straps to ensure it won’t come in contact with the window or window regulator mechanism. The manual door lock rod must be removed or cut off so it won’t contact the upper edge of the ABS Door Panel once installed. (See **photo #1**)



Photo #1

3. Remove the door fastener components with the exception of bolts and/or screws. Note that these are squeeze tabs and must be released from inside the doorframe in front of the window. A small screwdriver may be used to release one side, and then pry from the front. (See **photos #2**) for parts to be removed.

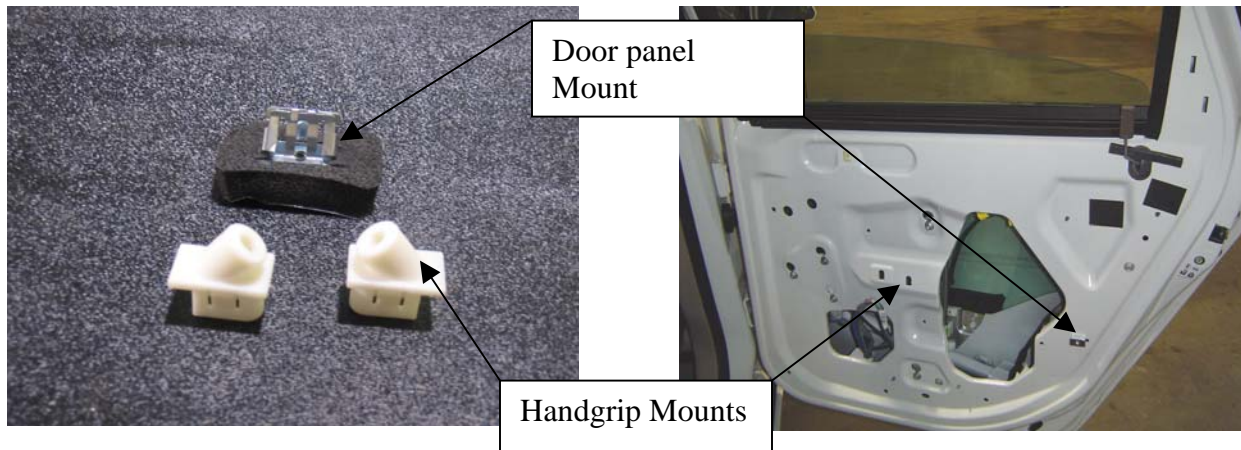

Photo #2

Photo #3

4. Install the ABS door panel (See **photo #4**) using the 3X72 self-drilling Philips head screws. Be sure that all wires and other door components are free and clear before drilling.
5. After installing the ABS door panel, re-install the black, plastic cover that was removed along with the O.E.M door panel. See location callout in photo #3.



Photo #4

Note: Pro-Gard Products, LLC insists that only the screws that are provided be used for this installation.

WINDOW BARS W/ ABS DOOR PANEL

1. To install the window bars along with the ABS door panel: pull away the weather strip from the top of the door (**See photo #1**).
2. Place the bottom of the window bars into the window trim recess.
3. From the outside, pull the weather strip down and away from the upper doorframe. Push the window bars into place so that the clips are fully engaged. Slide the weather strip back into the door channel making sure it overlaps the inner clip as the weather strip is seated. (**See the following photos**)



Photo #1



Weather strip



WINDOW BARS W/ ORIGINAL DOOR PANEL

1. To install the window bars along with the OEM door panel, follow the previous install instructions for the window bars with ABS door panels. (**See the following photos**)



IF THERE ARE ANY QUESTIONS OR CONCERNS PLEASE CONTACT:

PRO-GARD PRODUCTS, LLC

Phone: 317-579-6680

Fax: 317-579-6681